









FÖRKLARINGAR

INSTALLATIONER

- = TAPPKALLVATTEN
- = TAPPKALLVATTENCIRKULATION
- = TAPPVARMVATTEN
- = TAPPVARMVATTENCIRKULATION
-  = REGLERVENTIL
-  = AVSTÄNGNINGSVENTIL
-  = BACKVENTIL
-  = STYRVENTIL
-  = BLANDNINGSVENTIL
-  = CIRKULATIONSPUMP
-  = TERMOMETER
-  = GIVARE

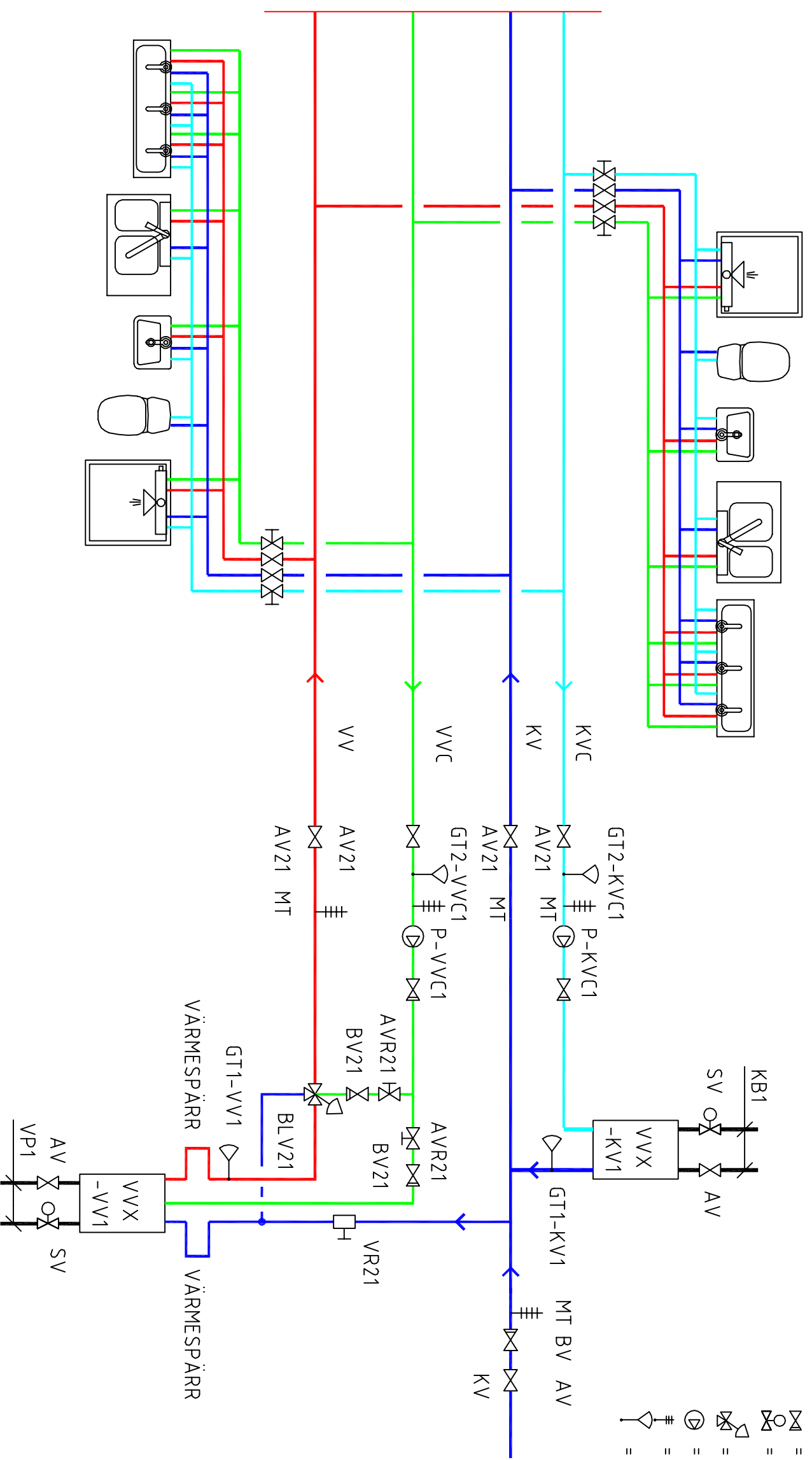

FLÖDESSCHEMA SYNLLIG INSTALLATION